

## Features

- Low Cost
- Small Size and Low Profile
- Excellent Repeatability (Lot-to-Lot Variation)
- Typical Isolation: 23 dB
- Typical Amplitude Balance: 0.8 dB
- Typical Insertion Loss: 1.4 dB
- SOIC-16 Package

## Description

M/A-COM's DS54-0006 is an IC-based monolithic power splitter/combiner in a low cost SOIC-16 plastic package. This device is ideally suited for applications where PCB real estate is at a premium and standard packaging for automated assembly and low cost are critical. Typical applications include infrastructure, portables, and peripheral devices (PCMCIA cards) for wireless standards such as PCS, PCN, DECT, PHS, and DCS-1800. Available in Tape and Reel.

The DS54-0006 is fabricated using a passive-integrated circuit process. The process features full-chip passivation for increased performance and reliability.

## Ordering Information

Part Number	Package
DS54-0006	Bulk Packaging
DS54-0006-TR	1000 piece reel
DS54-0006-TB	Sample Test Board

Note: Reference Application Note M513 for reel size information.

## Functional Block Diagram<sup>1</sup>

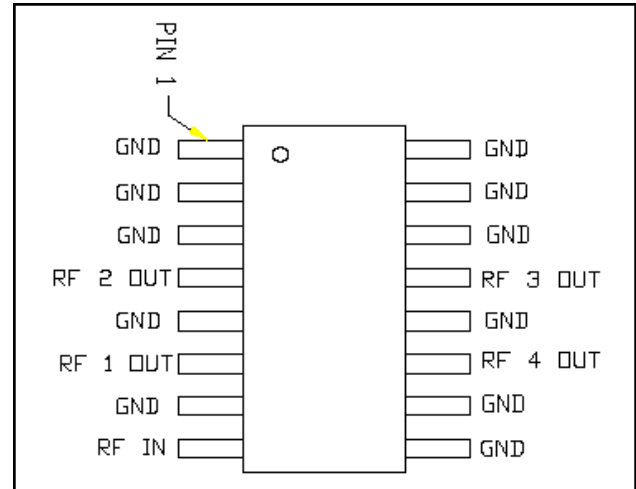

1. All unused pins must be RF and DC grounded.

## Pin Configuration

Pin No.	Function	Pin No.	Function
1	GND	9	GND
2	GND	10	GND
3	GND	11	RF 4 OUT
4	RF 2 OUT	12	GND
5	GND	13	RF 3 OUT
6	RF 1 OUT	14	GND
7	GND	15	GND
8	RF IN	16	GND

**Electrical Specifications:  $T_A = 25^\circ\text{C}$ ,  $Z_0 = 50\Omega$**

Parameter	Units	Min	Typ	Max
Insertion Loss above 6.0 dB	dB	—	1.4	1.7
Isolation 1700 - 2000	dB	18	23	—
VSWR Output	—	—	1.2:1	1.7:1
Input 1700 – 1880	—	—	1.6:1	2.0:1
Input 1880 – 2000	—	—	1.4:1	1.7:1
Amplitude Balance	dB	—	0.8	1.3
Phase Balance	Deg	—	5	10

**Absolute Maximum Ratings <sup>2,3</sup>**

Parameter	Absolute Maximum
Input Power <sup>4</sup>	1 W CW
Operating Temperature	-40°C to +85°C
Storage Temperature	-65°C to +150°C

- Exceeding any one or combination of these limits may cause permanent damage to this device.
- M/A-COM does not recommend sustained operation near these survivability limits.
- With internal load dissipation of 0.125 W Maximum.

**Handling Procedures**

Please observe the following precautions to avoid damage:

**Static Sensitivity**

GMIC Circuits are sensitive to electrostatic discharge (ESD) and can be damaged by static electricity. Proper ESD control techniques should be used when handling these devices.

**Typical Performance Curves @25°C**

*Insertion Loss vs. Frequency*

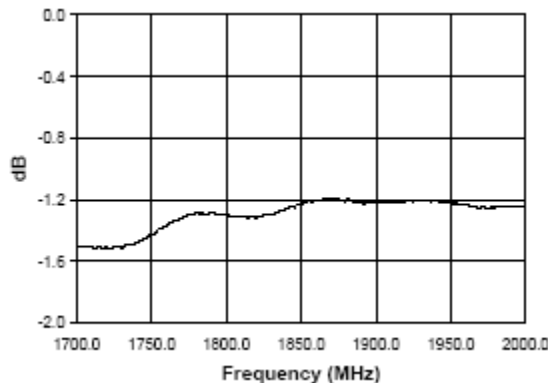

*Amplitude Balance vs. Frequency*

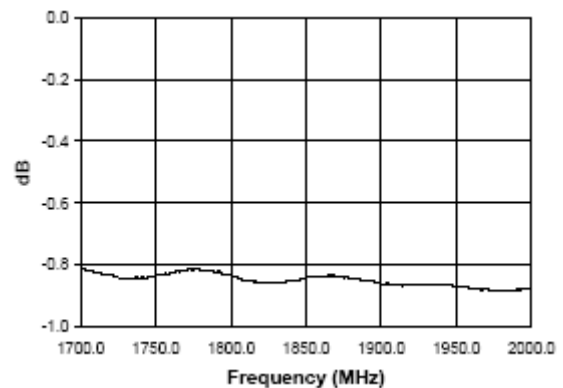

## Typical Performance Curves @25°C

*Isolation vs. Frequency*

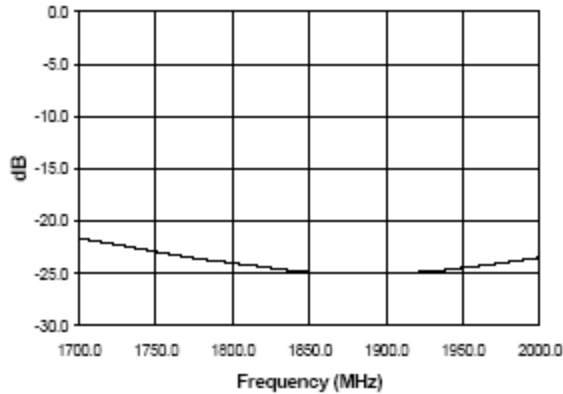

*Phase Balance vs. Frequency*

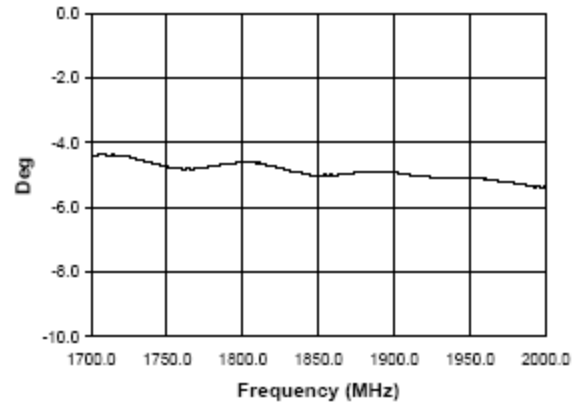

*I/P VSWR vs. Frequency*

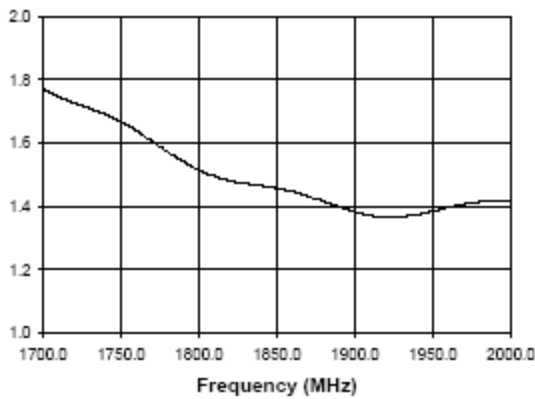

*O/P VSWR vs. Frequency*

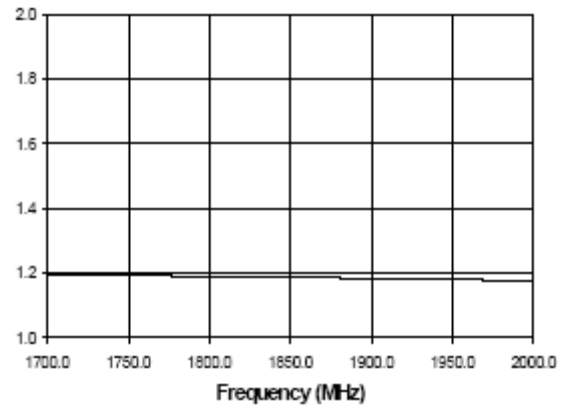

## SOIC-16<sup>†</sup>

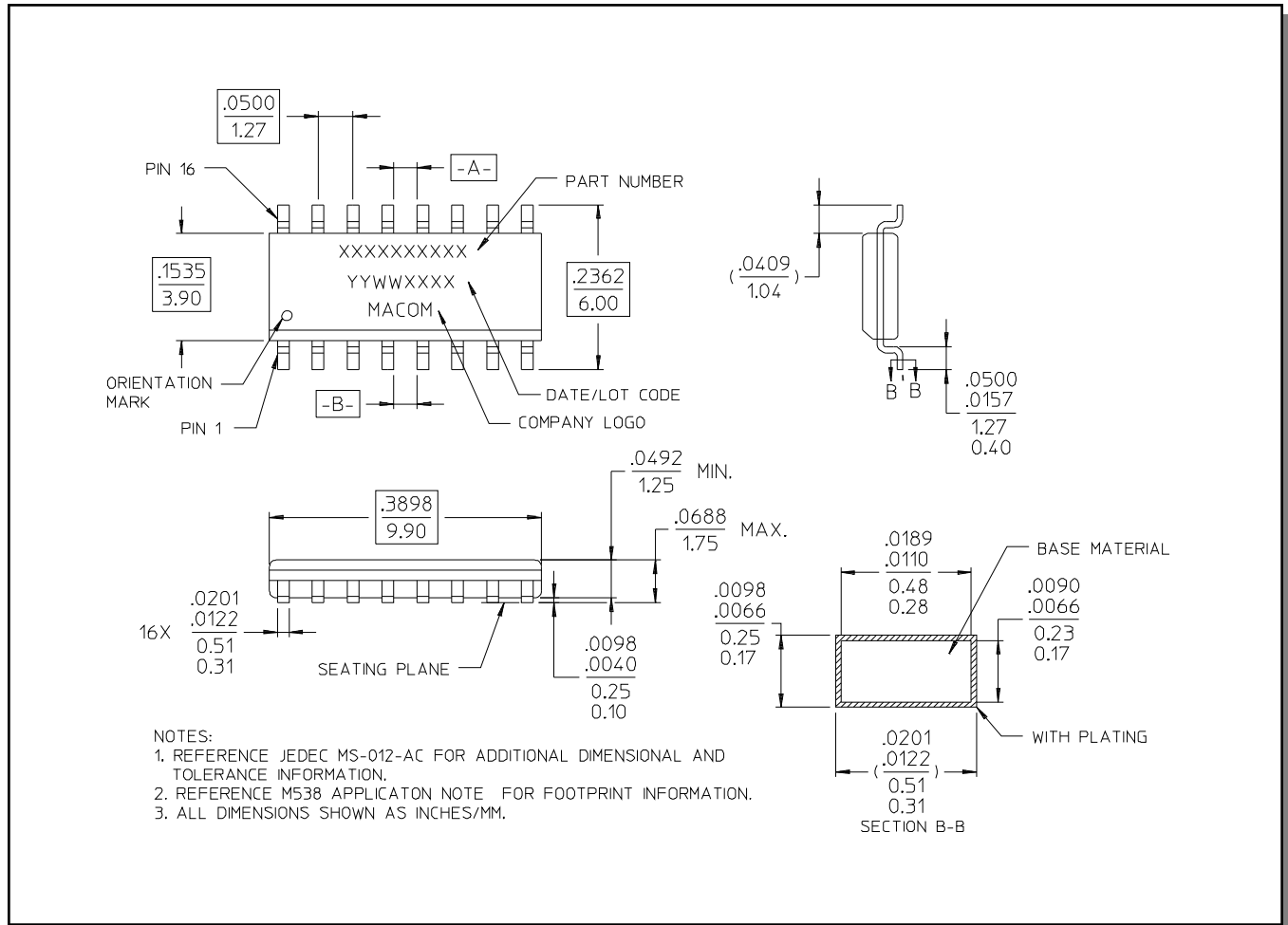

<sup>†</sup> Reference Application Note M538 for lead-free solder reflow recommendations.